

Article number: 021816011114

Description: Clamp with bracket and rubber
SPGU 6011. 114/30 SK

Measures

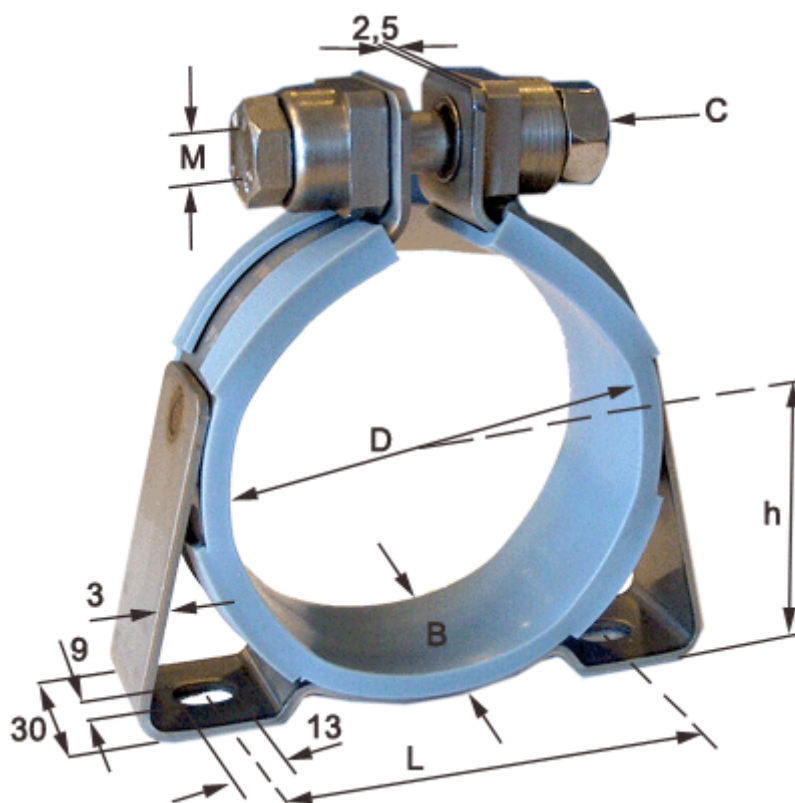

C (screw type) = SK hexagon screw

Diameter D = 114

h = 66

L = 100

Width B = 30